



TYPHOON INTAKE SYSTEMS

INTAKE SYSTEMS FOR VEHICLES LISTED ARE 50 STATE LEGAL. SEE KNFILTERS.COM FOR CARB STATUS ON EACH PART FOR A SPECIFIC VEHICLE.

INSTALLATION INSTRUCTIONS

69-4518TTK CHEVROLET 2008-10 Cobalt SS L4-2.0L turbo

TOOLS NEEDED:

Ratchet
Extension
10mm Socket
5/16" Socket
10mm Wrench
3mm Allen Key
Flat Blade Screwdriver
Phillips Screwdriver
5/8" Wrench

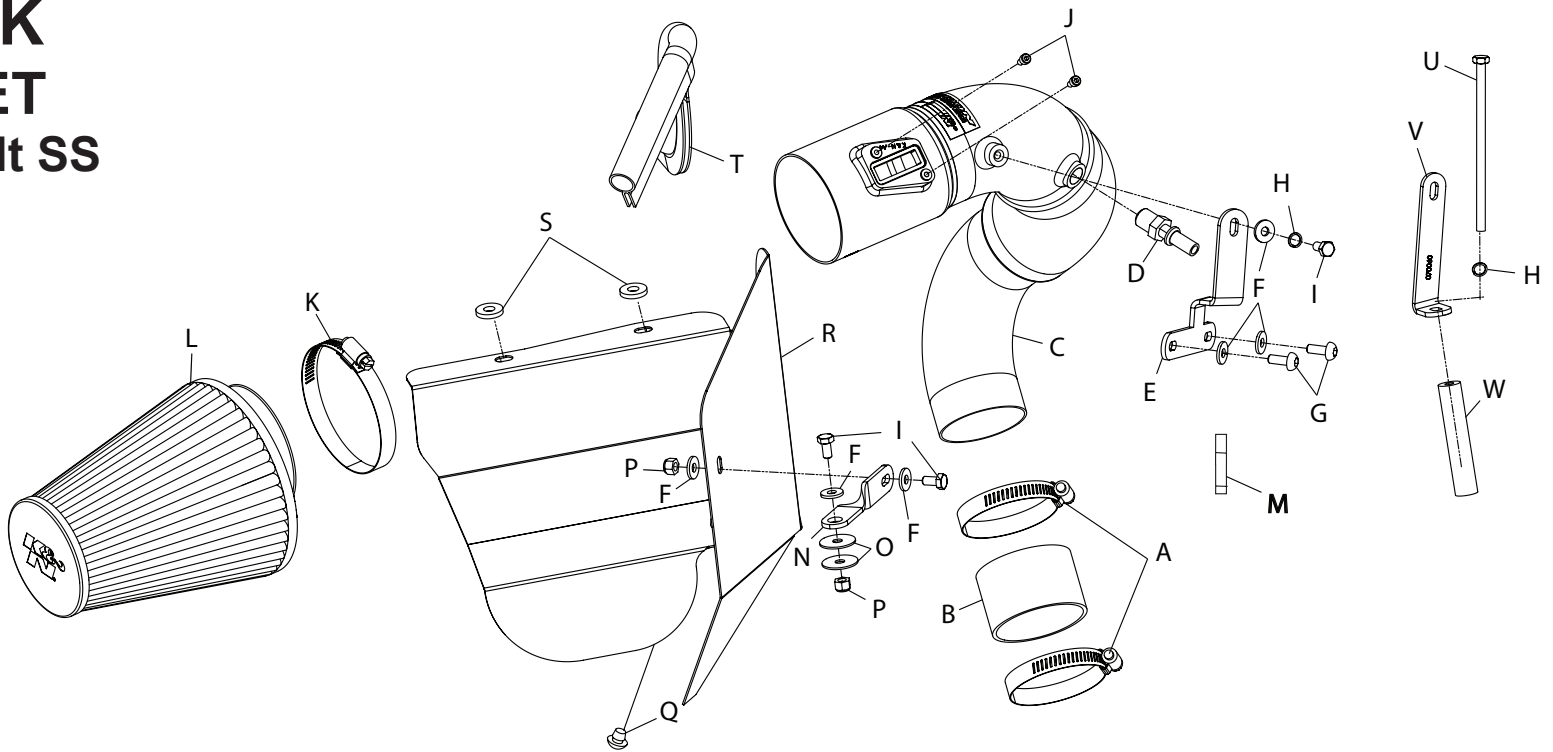

PARTS LIST:

Description	Qty.	Part #	Description	Qty.	Part #	Description	Qty.	Part #
A Hose Clamp #36	2	08530	I Bolt; 6MM-1.00 X 16MM, SS	3	07812	Q Plug, Rubber for RX Tops	1	08162
B Hose; 2-1/2" ID X 1-3/4" L	1	08727	J Bolt; M4 - 0.07 8MM, A/H Cap	2	07733	R Heat Shield	1	073118
C Intake Tube	1	27460	K Hose Clamp # 52	1	08610	S Washer; 5/16"ID X 3/4"OD, 1/8"THK	2	08129
D Vent; STRT, 1/4" NPT	1	08938	L Air Filter	1	RC-4470	T Edge Trim (15")	1	102474
E Bracket; "T", STL, TK/PC	1	083123	M Threadlocker	1	482	U Bolt; m6x1.00x118mm hex hd	1	22215
F Washer; 1/4"ID X 5/8"OD - SAE	6	08275	N Bracket; Short Twist	1	070702	V Bracket; "L"	1	070060
G Bolt; M6 X 1.00 X 16MM , BttnHd.	2	07730	O Washer; 1"D X 1/4 Hole Fender	2	08160	W Spacer; 625"odX.250"idX3.125" L	1	06404
H Washer; 1/4" LOCK, ZN	2	08198	P Nut; 6MM Nylock, Hexhead, SS	2	07512			

NOTE: FAILURE TO FOLLOW INSTALLATION INSTRUCTIONS AND NOT USING THE PROVIDED HARDWARE MAY DAMAGE THE INTAKE TUBE, THROTTLE BODY AND ENGINE.

TO START:

1. Turn off the ignition and disconnect the negative battery cable.

NOTE: Disconnecting the negative battery cable erases pre-programmed electronic memories. Write down all memory settings before disconnecting the negative battery cable. Some radios will require an anti-theft code to be entered after the battery is reconnected. The anti-theft code is typically supplied with your owner's manual. In the event your vehicles' anti-theft code cannot be recovered, contact an authorized dealership to obtain your vehicles anti-theft code.

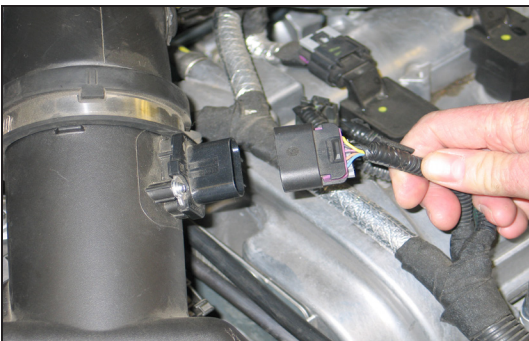

2. Disconnect the mass air sensor electrical connection as shown.



3. Release the locking tab and then disconnect the crank case vent hose from the stock intake tube.

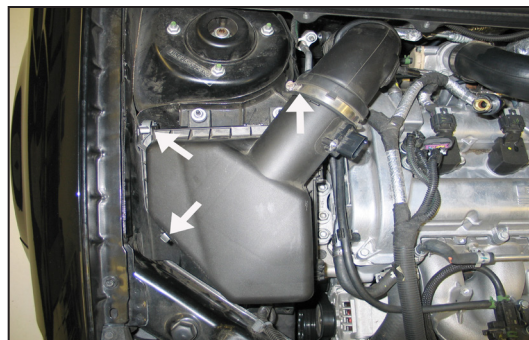

4. Loosen the hose clamp which secures the intake tube to the air box, release the two retaining clips and then remove the air box lid from the vehicle.



5. Remove the two lower air box retaining nuts shown.
NOTE: These nuts will be reused in a later step.



6. Pull up the lower air box to release it from the mounting gourmet and then remove the lower air box from the vehicle.

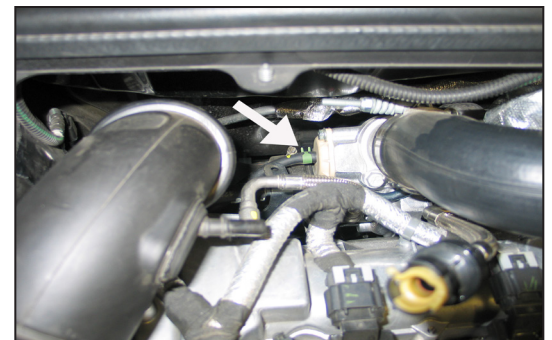

7. Loosen the hose clamp which secures intake tube to the turbo inlet.



8. Remove the intake tube from the vehicle.
NOTE: K&N Engineering, Inc., recommends that customers do not discard factory air intake.

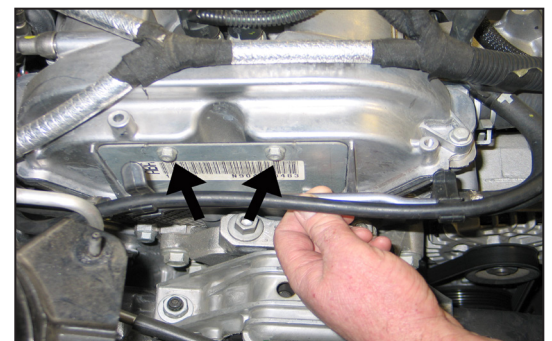

9. Lift the bypass hose assembly up to release it from mounting boss and then on vehicles equipped with an engine id plate, remove the two bolts shown.
NOTE: These bolts will not be reused.

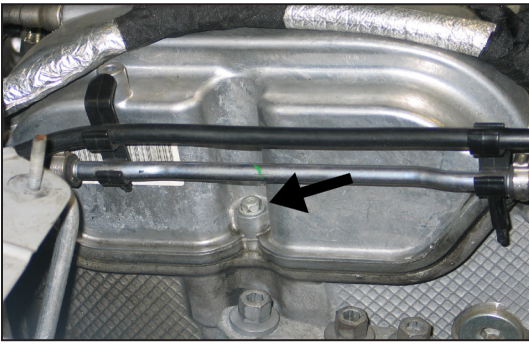

9a. On vehicles not equipped with a valve cover mounted engine id plate, lift the bypass hose assembly up from the mounting boss then remove the valve cover bolt shown.

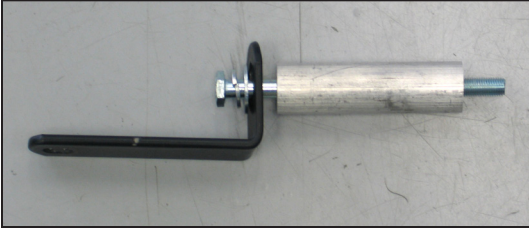

9b. On vehicles not equipped with a valve cover mounting engine id plate, assemble intake tube bracket (070060) using the provided hardware as shown.

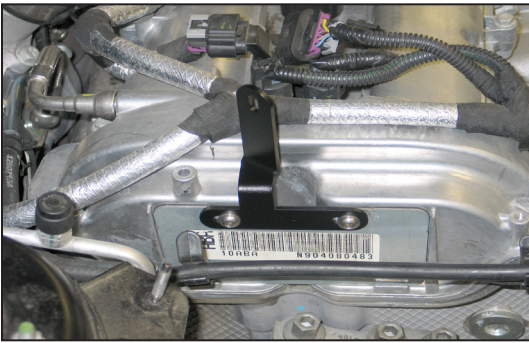

10. On vehicles equipped with a valve cover mounting engine id plate, install the tube mounting bracket (083123) onto the engine and secure it with the provided hardware. Reinstall the bypass hose back into the mounting boss.

NOTE: Be sure to apply the provided thread locking compound to the threads of the bolts securing the tube mounting bracket.

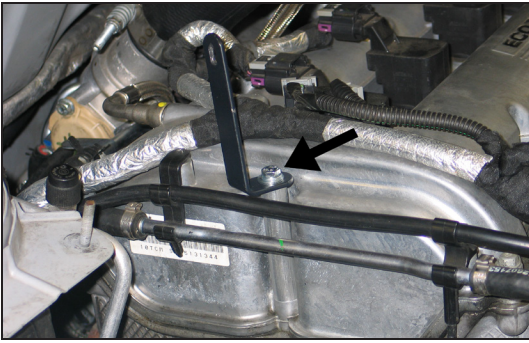

10a. On vehicles not equipped with a valve cover mounted engine id plate, install the tube mounting bracket assembly onto the engine and secure it with the provided hardware. Reinstall the bypass hose assembly back into the mounting boss.

NOTE: Be sure to apply the provided thread locking compound to the threads of the bolt securing the tube mounting bracket.

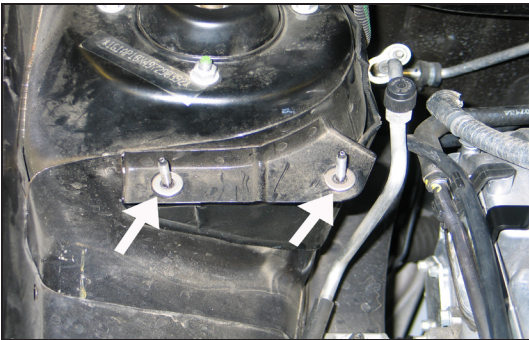

11. Install the two provided spacers onto the air box mounting studs as shown.

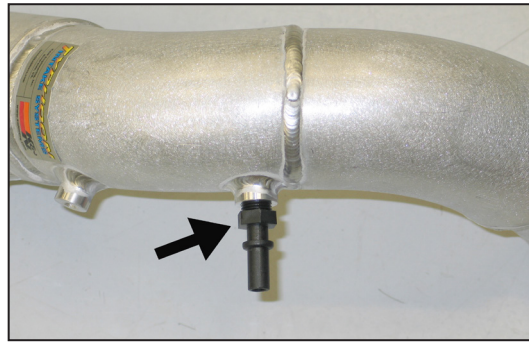

12. Install the quick release npt fitting into the K&N® intake tube as shown.

NOTE: Plastic NPT fittings are easy to cross thread. Install the vent fitting "hand" tight, then turn it two complete turns with a wrench.

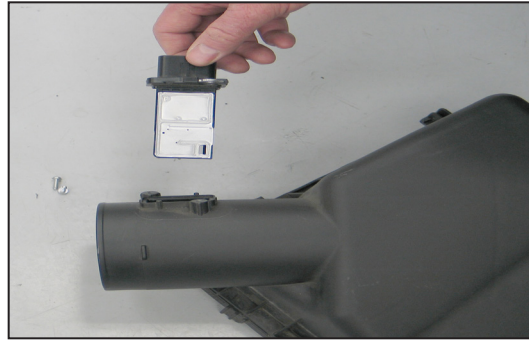

13. Remove the two mass air sensor retaining screws and then remove the mass air sensor from the air box as shown.



14. Install the mass air sensor into the K&N® intake tube and secure with the provided hardware.

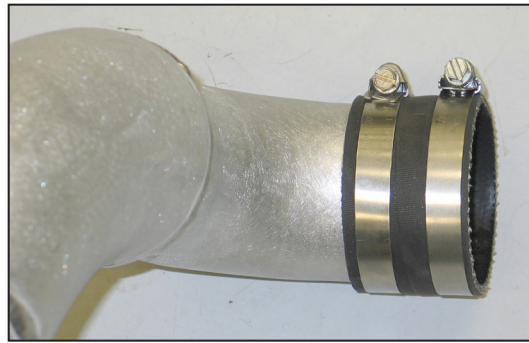

15. Install the provided silicone hose (08727) onto the K&N® intake tube and secure with the provided hose clamp.



16. Install the provided rubber bumper into the heat shield as shown.

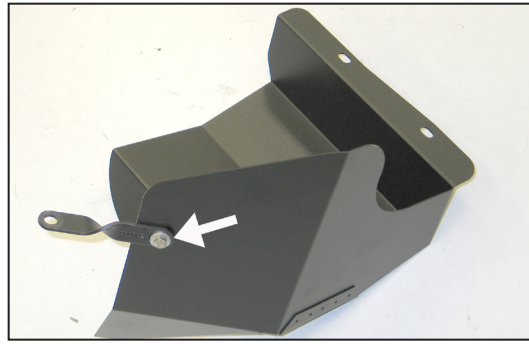

17. Install the heat shield mounting bracket (070702) onto the heat shield and secure with the provided hardware.

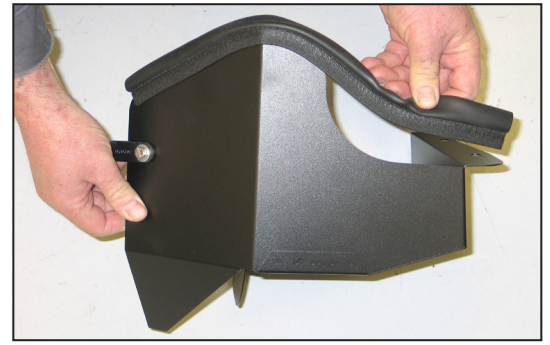

18. Install the provided edge trim onto the heat shield. Some trimming of the edge trim will be necessary.

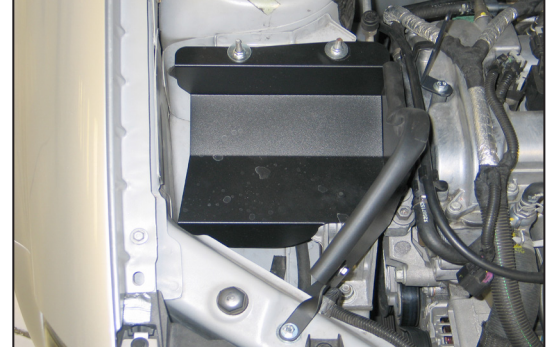

19. Set the heat shield into position on the air box mounting studs. Secure the mounting bracket to the core support with the provided hardware. Secure the heat shield to the mounting studs with the factory nuts removed in step #5.



20. Install the K&N® intake tube into position on the turbo inlet and align with the tube mounting bracket. Secure the intake tube with the provided hose clamp and hardware.



21. Connect the crank case vent hose to the quick connect fitting on the K&N® intake tube.



22. Install the K&N® air filter and secure with the provided hose clamp.
NOTE: Drycharger® air filter wrap; part # RC-4700DK is available to purchase separately. To learn more about Drycharger® filter wraps or look up color availability please visit <http://www.knfilters.com>®.

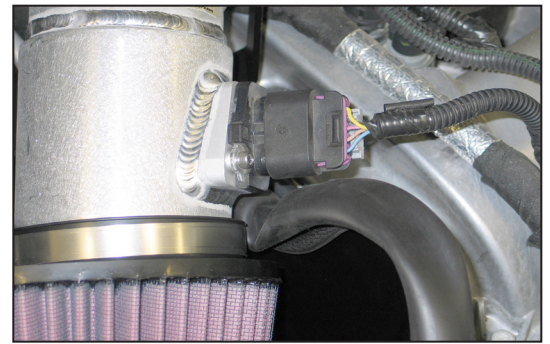

23. Reconnect the mass air sensor electrical connection.



24. Reconnect the vehicle's negative battery cable. Double check to make sure everything is tight and properly positioned before starting the vehicle.

25. The C.A.R.B. exemption sticker, (attached), must be visible under the hood so that an emissions inspector can see it when the vehicle is required to be tested for emissions. California requires testing every two years, other states may vary.

26. It will be necessary for all K&N® high flow intake systems to be checked periodically for realignment, clearance and tightening of all connections. Failure to follow the above instructions or proper maintenance may void warranty.

ROAD TESTING:

1. Start the engine with the transmission in neutral or park, and the parking brake engaged. Listen for air leaks or odd noises. For air leaks secure hoses and connections. For odd noises, find cause and repair before proceeding. This kit will function identically to the factory system except for being louder and much more responsive.

2. Test drive the vehicle. Listen for odd noises or rattles and fix as necessary.

3. If road test is fine, you can now enjoy the added power and performance from your kit.

4. K&N Engineering, Inc., requires cleaning the intake system's air filter element every 100,000 miles. When used in dusty or off-road environments, our filters will require cleaning more often. We recommend that you visually inspect your filter once every 25,000 miles to determine if the screen is still visible. When the screen is no longer visible some place on the filter element, it is time to clean it. To clean and re-oil, purchase our filter Recharger® service kit, part number 99-5050 or 99-5000 and follow the easy instructions.

INTAKE SYSTEMS FOR VEHICLES LISTED ARE 50 STATE LEGAL. SEE KNFILTERS.COM FOR CARB STATUS ON EACH PART FOR A SPECIFIC VEHICLE.